

DEAL: 1

♣	A 8 2
♦	K 10 6 3
♥	A Q 8 7
♠	K 9

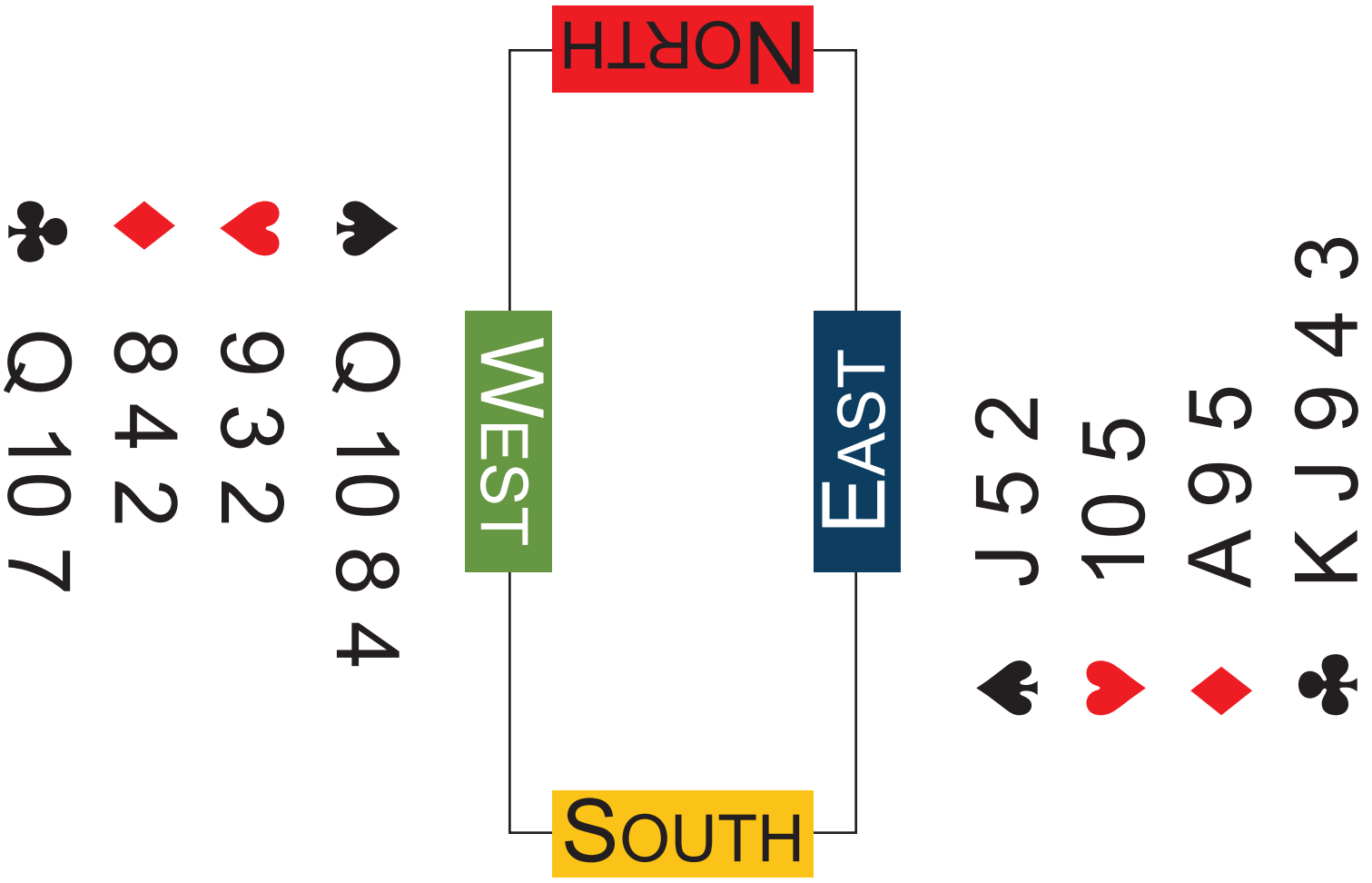

♠	A 7 6 3
♥	K J 6 4
♦	Q J 7
♣	9 5

DEAL: 1

NORTH



DEAL: 1
DLR: NORTH
VUL: NONE

EAST

SOUTH

WEST

DEAL: 2

♣	9 5 4
♦	Q J 10 8 3
♥	A 10
♠	8 5 2

NORTH

WEST

EAST

SOUTH

♠	9 6 3
♥	Q 9 5 4
♦	A 7
♣	A 7 6 3

♠	A Q J
♥	7 3 2
♦	K 6 5
♣	K Q J 8

♠	K 10 7 4
♥	K J 8 6
♦	9 4 2
♣	10 2

DEAL: 2

NORTH

DEAL: 2
DLR: EAST
VUL: N-S



EAST

WEST

SOUTH

DEAL: 3

♣	Q 6 2
♦	9 4
♥	A 7 6 3
♠	Q 10 8 4

NORTH

WEST

EAST

SOUTH

♠	A 6 2
♥	Q 9 2
♦	K 10 7
♣	10 8 7 3

♠	7 3
♥	J 10 8 4
♦	A J 8 5 2
♣	9 4

♠	K J 9 5
♥	K 5
♦	Q 6 3
♣	A K J 5

DEAL: 3

NORTH

DEAL: 3
DLR: SOUTH
VUL: E-W

EAST

WEST



SOUTH

DEAL: 4

♣	10 4
♦	Q 10 9 3 2
♥	A Q 9 4
♠	J 2

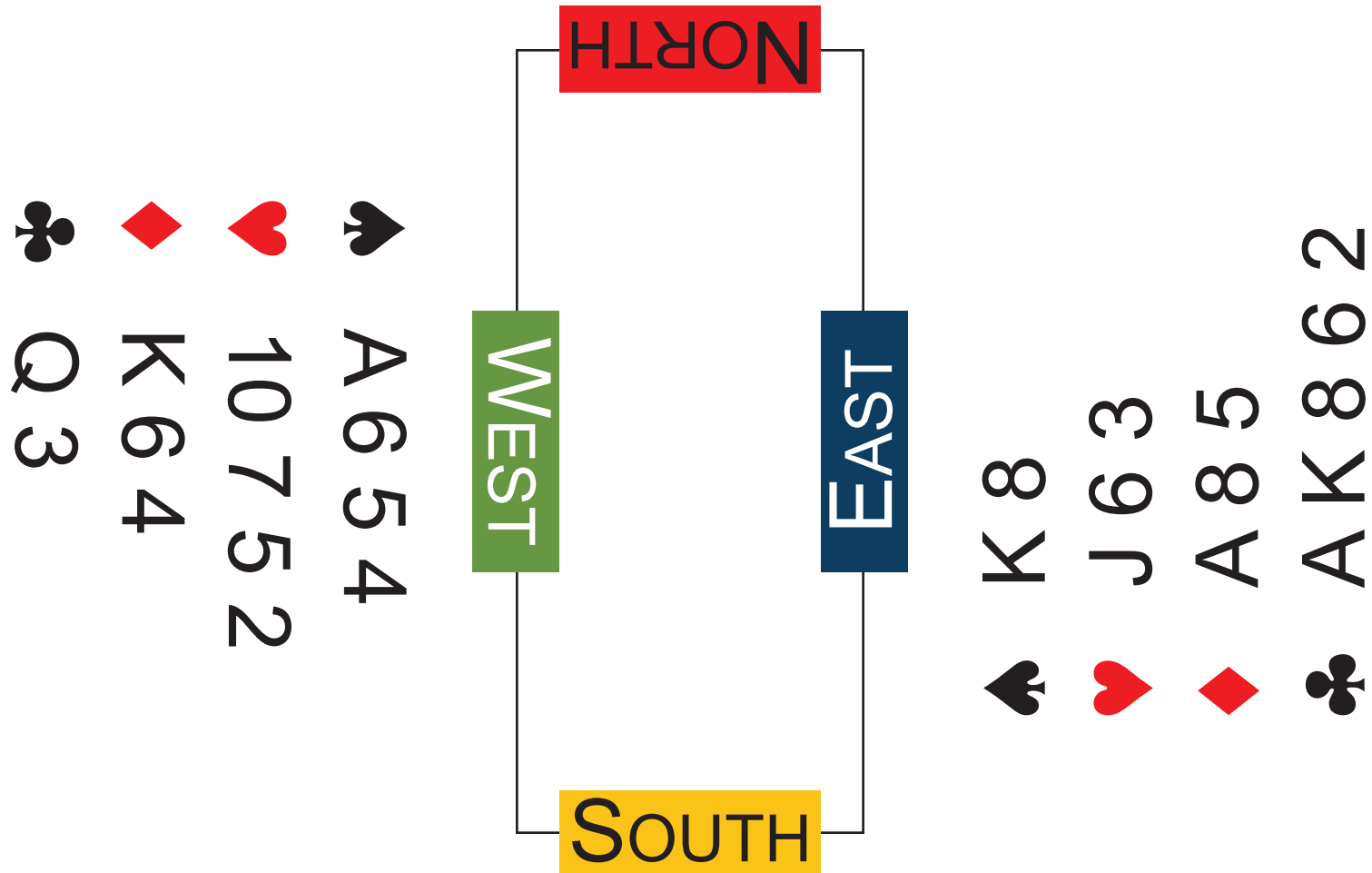

♣	A K 8 6 2
♦	5 8 A
♥	3 9 J
♠	K 8

DEAL: 4

NORTH

DEAL: 4
DLR: WEST
VUL: BOTH



WEST

EAST

SOUTH

DEAL: 5

♣	K Q J 3
♦	K 8 3
♥	A K J 5
♠	10 7

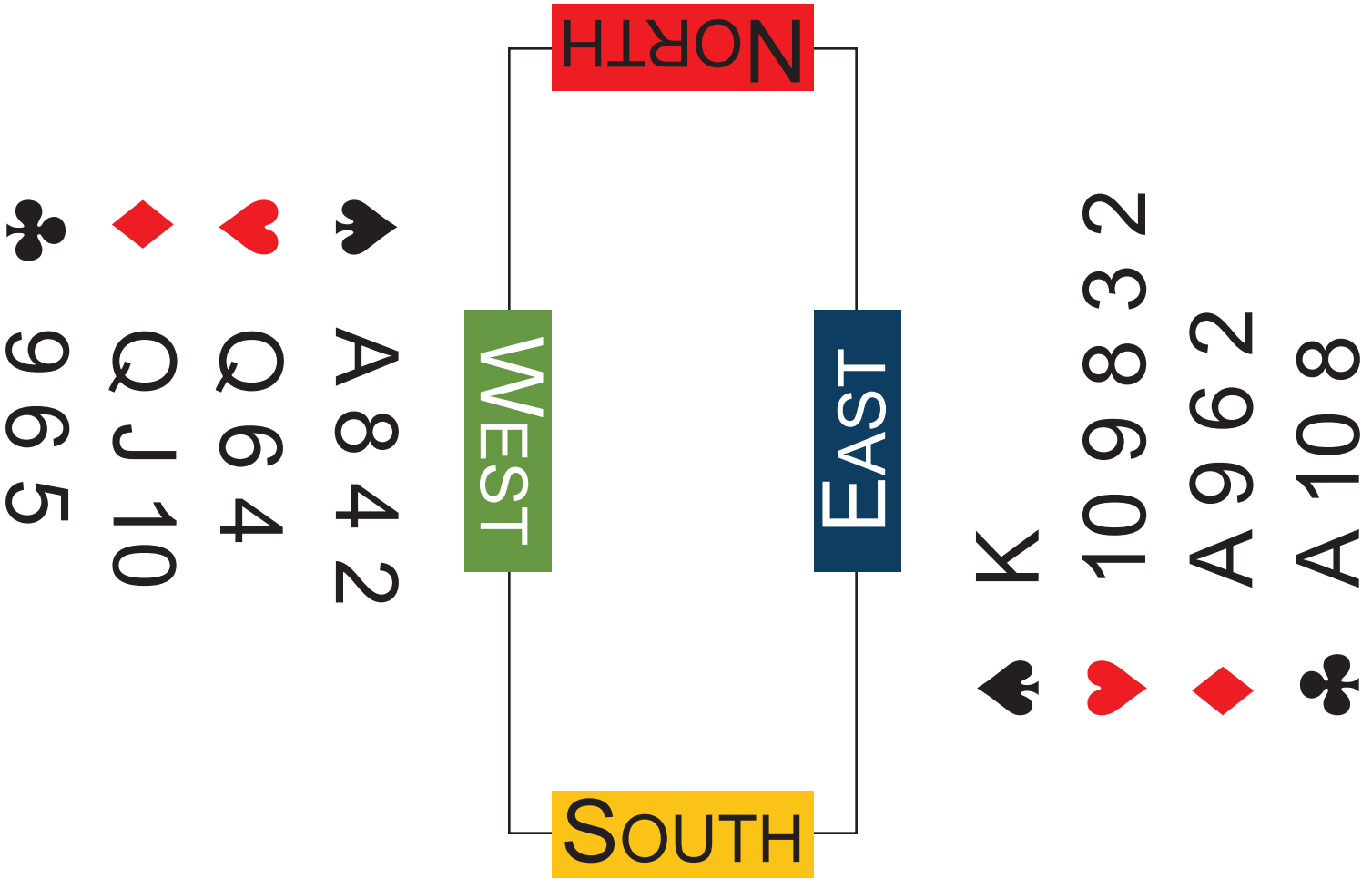

DEAL: 5

NORTH



DEAL: 5
DLR: NORTH
VUL: NONE

EAST

SOUTH

WEST

DEAL: 6

♣ K J 10 5

♦ 9 4

♥ J 9

♠ Q J 10 9 2

NORTH

WEST

EAST

SOUTH

♠ K 8 6 3

♥ A 4

♦ K 7 3

♣ A Q 6 2

♠ 7 4

♥ K Q 10

♦ Q J 10 8 5

♣ 9 7 3

♠ A 5

♥ 8 7 6 5 3 2

♦ A 6 2

♣ 8 4

DEAL: 6

NORTH

DEAL: 6
DLR: EAST
VUL: N-S



EAST

WEST

SOUTH

DEAL: 7

♣	J 6
♦	K J 9 5 4 2
♥	Q 6 3
♠	9 6

NORTH

WEST

EAST

SOUTH

♠	Q 10 8 4 3
♥	8 4
♦	A 8
♣	K 8 4 3

♠	A 7 2
♥	J 10 9 2
♦	Q 10 6
♣	Q 9 5

♠	K J 5
♥	A K 7 5
♦	7 3
♣	A 10 7 2

DEAL: 7

NORTH

DEAL: 7
DLR: SOUTH
VUL: E-W

EAST

WEST



SOUTH

DEAL: 8

♣ 5 4
 ♦ J 7 2
 ♥ A 9 7 6 3
 ♠ K 7 6

NORTH

WEST

EAST

SOUTH

♠ 8 2
 ♥ Q J 10 2
 ♦ K 6 4 3
 ♣ Q 10 6

♠ J 10 9 5 3
 ♥ K 5
 ♦ A 8
 ♣ J 9 7 2

♠ A Q 4
 ♥ 8 4
 ♦ Q 10 9 5
 ♣ A K 8 3

DEAL: 8

NORTH

DEAL: 8
DLR: WEST
VUL: BOTH



WEST

EAST

SOUTH

DEAL: 9

♣	A 9 5 4
♦	10 9 8 6 2
♥	9
♠	K 10 4

NORTH

♠	J 8 6 5 3
♥	10 7 3
♦	7 5
♣	K 6 2

WEST

EAST

SOUTH

♠	A Q
♥	A K Q J 8 4
♦	K Q J
♣	7 3

♠	9 7 2
♥	6 5 2
♦	A 4 3
♣	Q J 10 8

DEAL: 9

NORTH



DEAL: 9
DLR: NORTH
VUL: NONE

EAST

SOUTH

WEST

DEAL: 10

♣	A J 6
♦	Q 10 5
♥	K Q J
♠	A K Q J

NORTH

♠	10 9 8 7
♥	10 5
♦	A 9 7 3
♣	K Q 2

WEST

EAST

SOUTH

♣	10 8 4
♦	K 8 6
♥	A 9 7 4 3
♠	5 2

♠	6 4 3
♥	8 6 2
♦	J 4 2
♣	9 7 5 3

DEAL: 10

NORTH

DEAL: 10
DLR: EAST
VUL: N-S



EAST

SOUTH

WEST

DEAL: 11

♣	A 5
♦	A K Q J 10 7 6
♥	A Q
♠	8 6

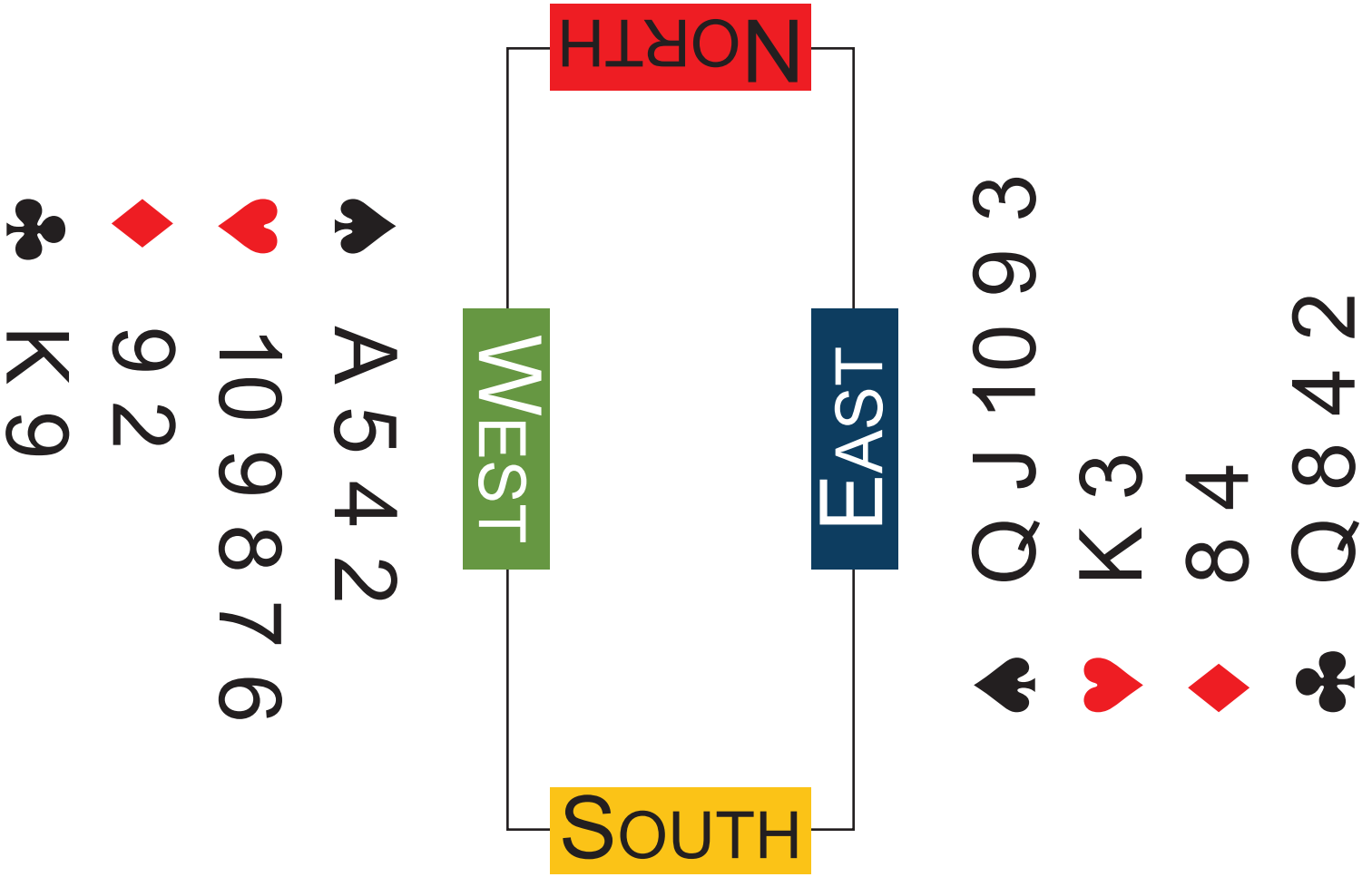

♠	K 7
♥	J 5 4 2
♦	5 3
♣	J 10 7 6 3

DEAL: 11

NORTH

DEAL: 11
DLR: SOUTH
VUL: E-W

EAST

WEST



SOUTH

DEAL: 12

♣	J 10 9 6
♦	10 8 7 4 2
♥	J 9 5 4
♠	—

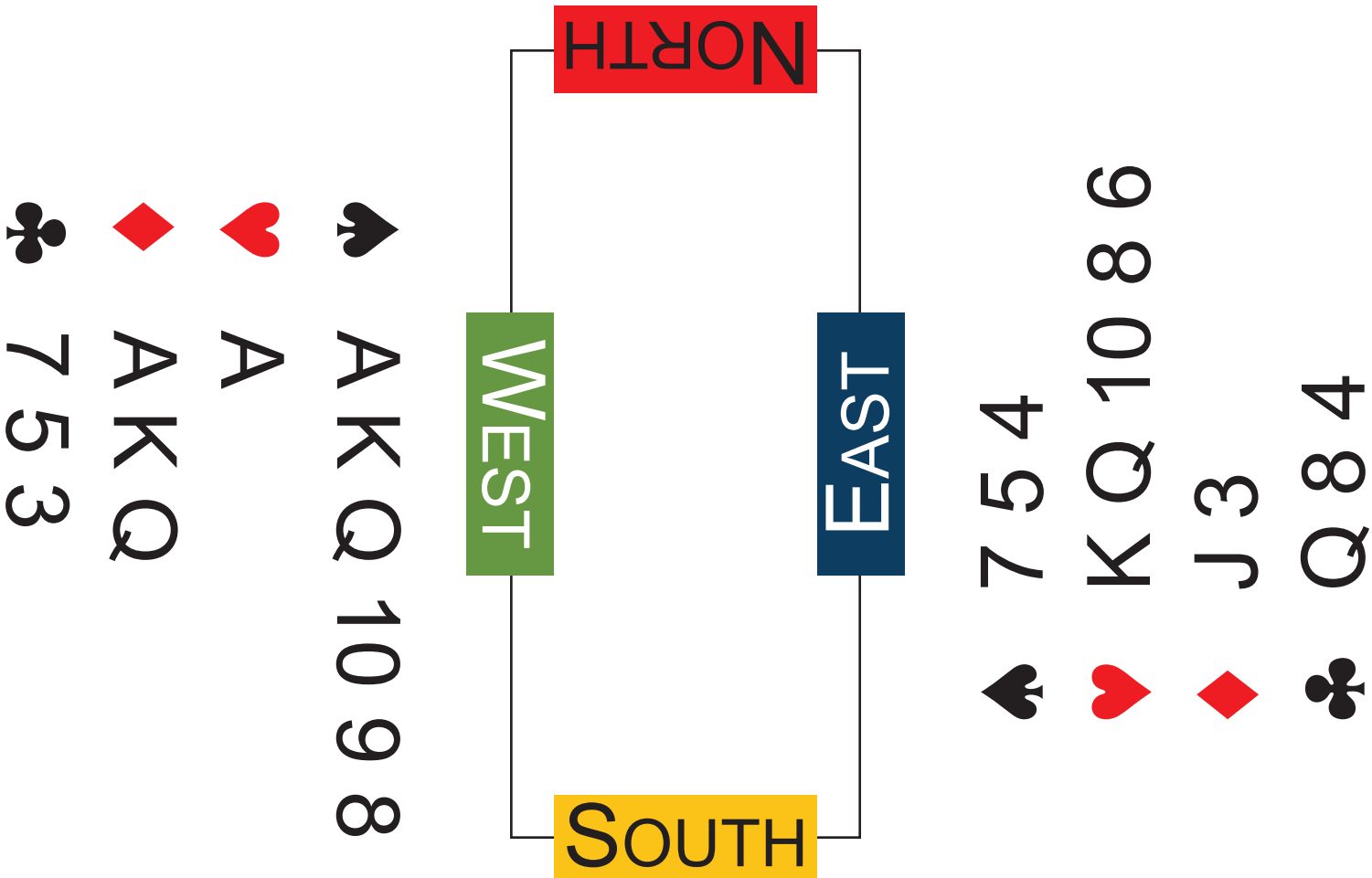

♠	J 6 3 2
♥	7 3 2
♦	9 6 5
♣	AK 2

DEAL: 12

NORTH

DEAL: 12
DLR: WEST
VUL: BOTH



WEST

EAST

SOUTH

DEAL: 13

♣	Q 9 6 3
♦	A 10
♥	A Q 6
♠	Q J 4 3

NORTH

WEST

EAST

SOUTH

♠	10 9 8 6 5
♥	K 5
♦	K 8
♣	8 5 4 2

♠	7 2
♥	J 10 8 4 2
♦	9 6 4 3 2
♣	10

♠	A K
♥	9 7 3
♦	Q J 7 5
♣	A K J 7

DEAL: 13

NORTH



DEAL: 13
DLR: NORTH
VUL: NONE

WEST

EAST

SOUTH

DEAL: 14

♣	9 7 3 2
♦	4 3
♥	9 4
♠	J 10 9 6 4

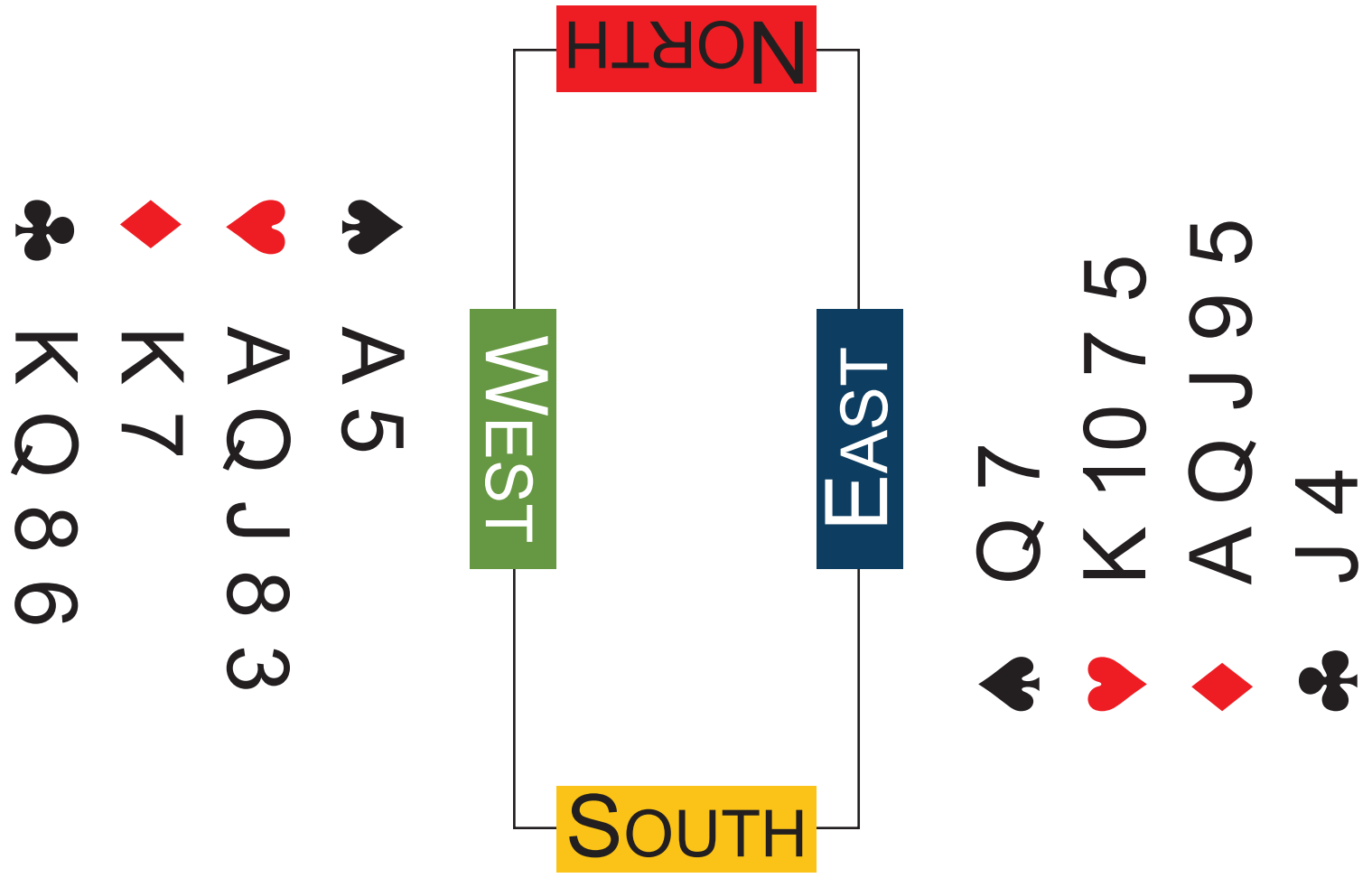

♠	K 8 3 2
♥	6 2
♦	10 8 6 2
♣	A 10 5

DEAL: 14

NORTH

DEAL: 14
DLR: EAST
VUL: N-S



EAST

WEST

SOUTH

DEAL: 15

♣ 9 5 3
 ♦ A 6 2
 ♥ 10 8 5 3 2
 ♠ 8 2

♠ A J 10 6
 ♥ K Q
 ♦ Q J
 ♣ K Q J 10 6

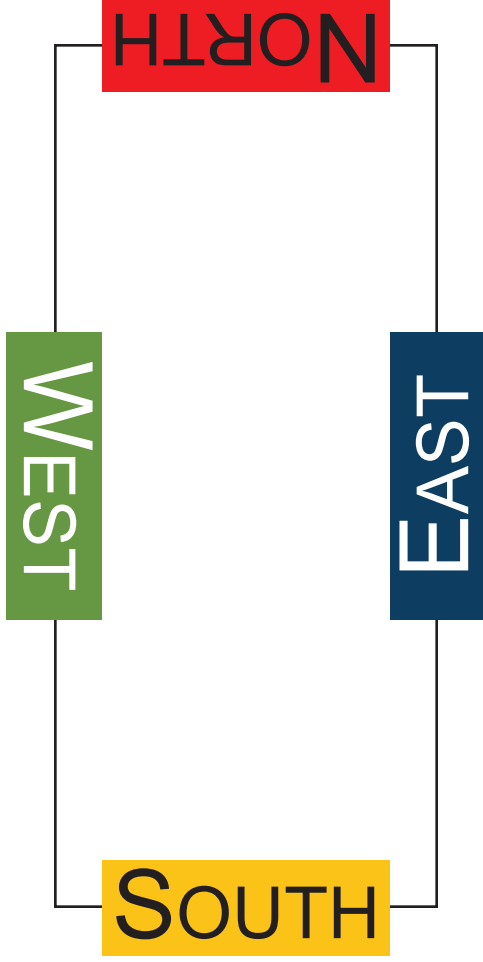

♠ K Q 9 7 5 3
 ♥ A J 7
 ♦ K 5 4
 ♣ 8

♠ 4
 ♥ 9 6 4
 ♦ 10 9 8 7 3
 ♣ A 7 4 2

DEAL: 15

NORTH

DEAL: 15
DLR: SOUTH
VUL: E-W

EAST

WEST



SOUTH

DEAL: 16

♣ A J 6
 ♦ 8 2
 ♥ A Q 7 4
 ♠ K J 7 3

NORTH

WEST

EAST

SOUTH

♠ 10 8 4
 ♥ J 6 3 2
 ♦ 4
 ♣ 10 9 8 7 2

♠ 9 6 5 2
 ♥ 10 8
 ♦ A 10 7
 ♣ K Q 5 4

♠ A Q
 ♥ K 9 5
 ♦ K Q J 9 6 5 3
 ♣ 3

DEAL: 16

NORTH

DEAL: 16
DLR: WEST
VUL: BOTH



WEST

EAST

SOUTH

DEAL: 17

♣ 10 9
 ♦ K 10 7 4
 ♥ 10 5 4 3
 ♠ Q 7 2

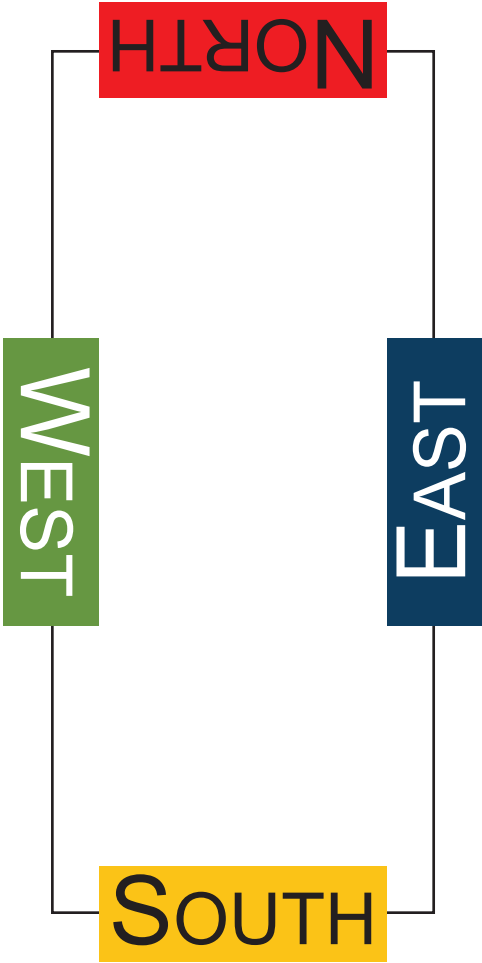

♣ Q 9 6 3
 ♦ A Q J 5
 ♥ A J 7
 ♠ J 6 3

♠ A 9 4
 ♥ K Q 9
 ♦ 8 6 3
 ♣ A K 5 4

♠ K 10 8 5
 ♥ 8 6 2
 ♦ 9 2
 ♣ J 8 7 2

DEAL: 17

NORTH



DEAL: 17
DLR: NORTH
VUL: NONE

EAST

WEST

SOUTH

DEAL: 18

♣ Q 7 3
 ♦ 10 7 3 2
 ♥ Q J 10 6
 ♠ J 7

NORTH

WEST

EAST

SOUTH

♠ A 5 3 2
 ♥ K 8 4
 ♦ 9 5 4
 ♣ 6 5 2

♠ K 10 8 6 4
 ♥ 5 3
 ♦ A 6
 ♣ 10 9 8 4

♠ Q 9
 ♥ A 9 7 2
 ♦ K Q J 8
 ♣ A K J

DEAL: 18

NORTH

DEAL: 18
DLR: EAST
VUL: N-S



EAST

WEST

SOUTH

DEAL: 19

♣	Q J 10 6 3
♦	K 10 4
♥	K 3
♠	8 6 4

NORTH

WEST

EAST

SOUTH

♠	A 2
♥	J 10 8 7 4 2
♦	Q 7 3
♣	8 5

♠	K 9 5
♥	Q 9 5
♦	A 9 8 6 5
♣	A K

♠	Q J 10 7 3
♥	A 6
♦	J 2
♣	9 7 4 2

DEAL: 19

NORTH

DEAL: 19
DLR: SOUTH
VUL: E-W

EAST

WEST



SOUTH

DEAL: 20

♣ A 10 5
♦ A K 6 5 3
♥ A K
♠ A K J

NORTH

WEST

EAST

SOUTH

♠ 10 9 8 7 5
♥ J 7 2
♦ J 7
♣ K 9 2

♠ Q 2
♥ Q 8 4 3
♦ Q 10 9 2
♣ Q 8 6

♠ 6 4 3
♥ 10 9 6 5
♦ 8 4
♣ J 7 4 3

DEAL: 20

NORTH

DEAL: 20
DLR: WEST
VUL: BOTH



WEST

EAST

SOUTH

DEAL: 21

♣	9 6 3
♦	7 5 4
♥	Q J 10 6 2
♠	K 6

NORTH

WEST

EAST

SOUTH

♠	9 5
♥	9 7 5 4 3
♦	J 10 9
♣	Q J 10

♠	A 7 4 2
♥	A K
♦	A K 6 3
♣	K 7 5

♠	Q J 10 8 3
♥	8
♦	Q 8 2
♣	A 8 4 2

DEAL: 21

NORTH



DEAL: 21
DLR: NORTH
VUL: NONE

EAST

WEST

SOUTH

DEAL: 22

♣	8 2
♦	6 2
♥	10 9 8 5 3
♠	10 7 5 3

NORTH

♠	J 2
♥	Q 7 6
♦	9 3
♣	A Q 10 9 7 5

WEST

EAST

SOUTH

♣	K J 6 3
♦	A K J 7 4
♥	J
♠	A K Q

♠	9 8 6 4
♥	A K 4 2
♦	Q 10 8 5
♣	4

DEAL: 22

NORTH

DEAL: 22
DLR: EAST
VUL: N-S



EAST

WEST

SOUTH

DEAL: 23

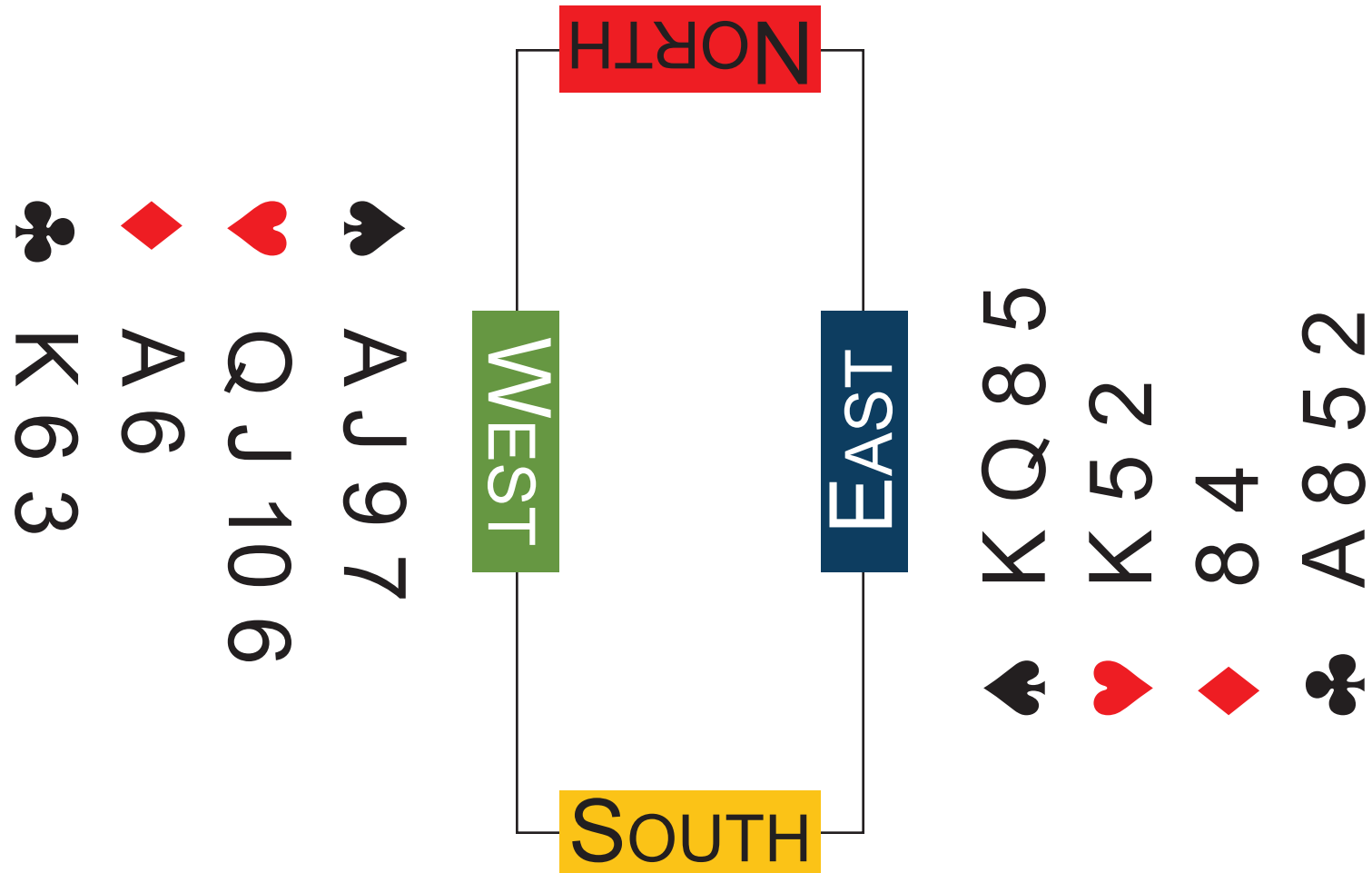

DEAL: 23

NORTH

DEAL: 23
DLR: SOUTH
VUL: E-W

EAST

WEST



SOUTH

DEAL: 24

♣	K Q	♠	A K J 9 5
♦	K Q J 6 3	♥	5

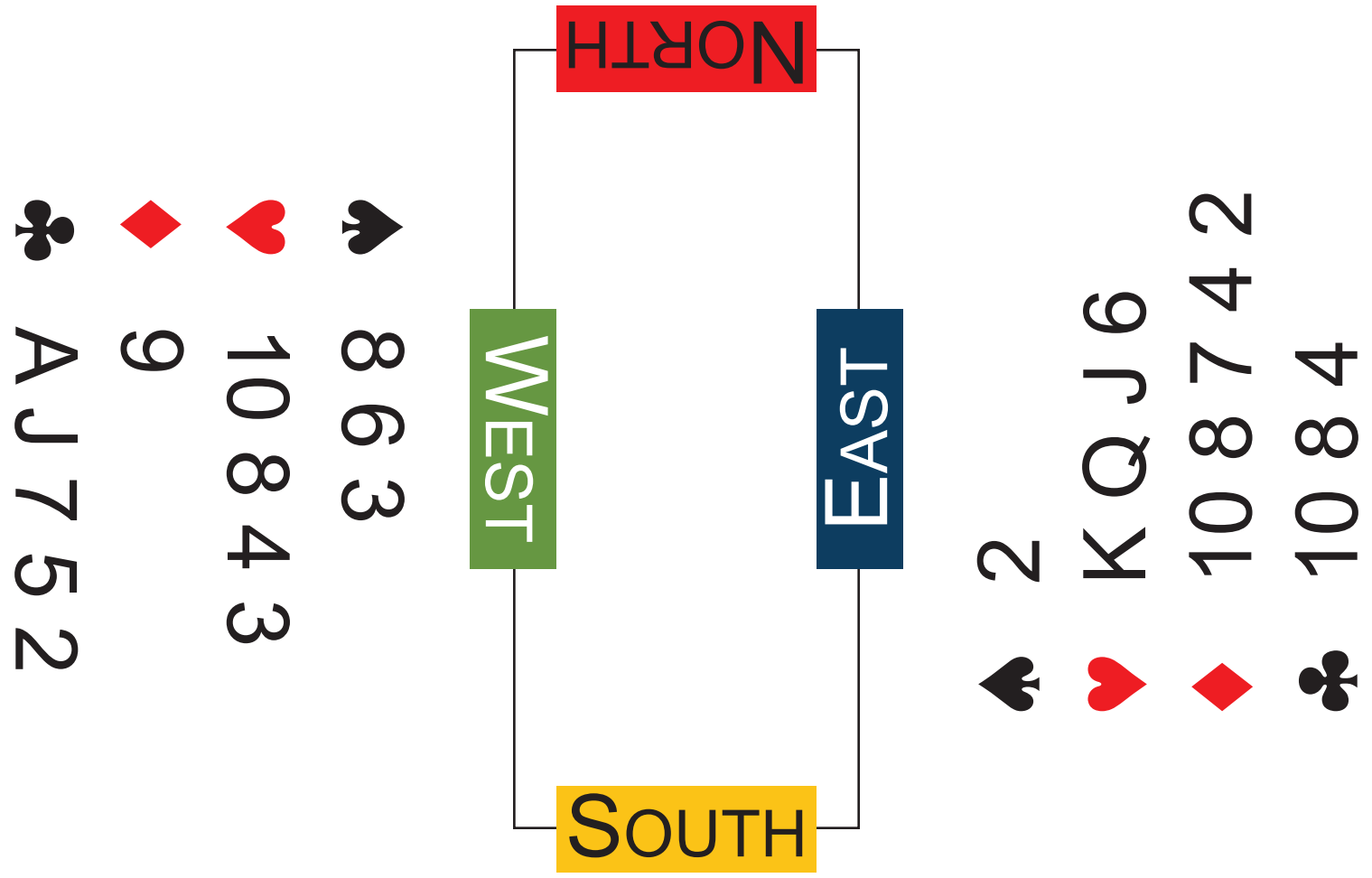

♠	Q 10 7 4
♥	A 9 7 2
♦	A 5
♣	9 9 3

DEAL: 24

NORTH

DEAL: 24
DLR: WEST
VUL: BOTH



WEST

EAST

SOUTH

DEAL: 25

♣ 10 7 5

♦ K 9 8 6 3

♥ 9 3

♠ K J 4

NORTH

WEST

EAST

SOUTH

♠ Q 9 5 3

♥ Q 10 7 4

♦ 10 4

♣ 9 6 2

♠ 10 6 2

♥ A 6 2

♦ Q 7 5 2

♣ 8 4 3

DEAL: 25

♠ A 8 7
♥ K J 8 5
♦ A J
♣ A K Q J

NORTH



DEAL: 25
DLR: NORTH
VUL: NONE

EAST

WEST

SOUTH

DEAL: 26

♣	Q 9
♦	5
♥	Q 10 9 6 3
♠	A 8 7 5 2

NORTH

WEST

EAST

SOUTH

♠	K Q 10 9
♥	8 4
♦	A 8 4 2
♣	10 7 3

♠	6 3
♥	A 7
♦	K J 10 9 6
♣	8 5 4 2

♠	J 4
♥	K J 5 2
♦	Q 7 3
♣	A K J 6

DEAL: 26

NORTH

DEAL: 26
DLR: EAST
VUL: N-S



EAST

WEST

SOUTH

DEAL: 27

♣ J 5
 ♦ K Q 9 4
 ♥ Q J 6
 ♠ K Q J 8

SOUTH

NORTH

WEST

EAST

♣ 8 2
 ♦ 8 7 5 3
 ♥ 10 4 2
 ♠ A 10 6 2

♠ 9 7 5 4
 ♥ A 9 8 5 3

♦ 10 6

♣ A 4

♠ 3

♥ K 7

♦ A J 2

♣ K Q 10 9 7 6 3
 DEAL: 27

NORTH

These deal records are to be used only when accompanied
by Audrey Grant Better Bridge texts and software
© 2014 Audrey Grant's Better Bridge Inc.
www.AudreyGrant.com

DEAL: 27
DLR: SOUTH
VUL: E-W

WEST

EAST



SOUTH

DEAL: 28

♣	K 10 7 6 3
♦	A 2
♥	8 4 3
♠	6 4 2

NORTH

WEST

EAST

SOUTH

♠	A Q 7 5
♥	K Q 9 5 2
♦	6 5 4
♣	8

♠	K J 9
♥	A J 7
♦	K Q 7 3
♣	J 5 2

♠	10 8 3
♥	10 6
♦	J 10 9 8
♣	A Q 6 4

DEAL: 28

NORTH

DEAL: 28
DLR: WEST
VUL: BOTH



WEST

EAST

SOUTH

DEAL: 29

♣	A 8 6 3
♦	K Q J
♥	K 9 3
♠	K J 5

NORTH

WEST

EAST

SOUTH

♣	K J 10 9 2
♦	A 4 3
♥	J 6 2
♠	6 3

♠	Q 7 4 2
♥	Q 8 5 4
♦	10 9 7 5 2
♣	—

♠	A 10 9 8
♥	A 10 7
♦	8 6
♣	Q 7 5 4

DEAL: 29

NORTH



DEAL: 29
DLR: NORTH
VUL: NONE

WEST

EAST

SOUTH

DEAL: 30

DEAL: 30

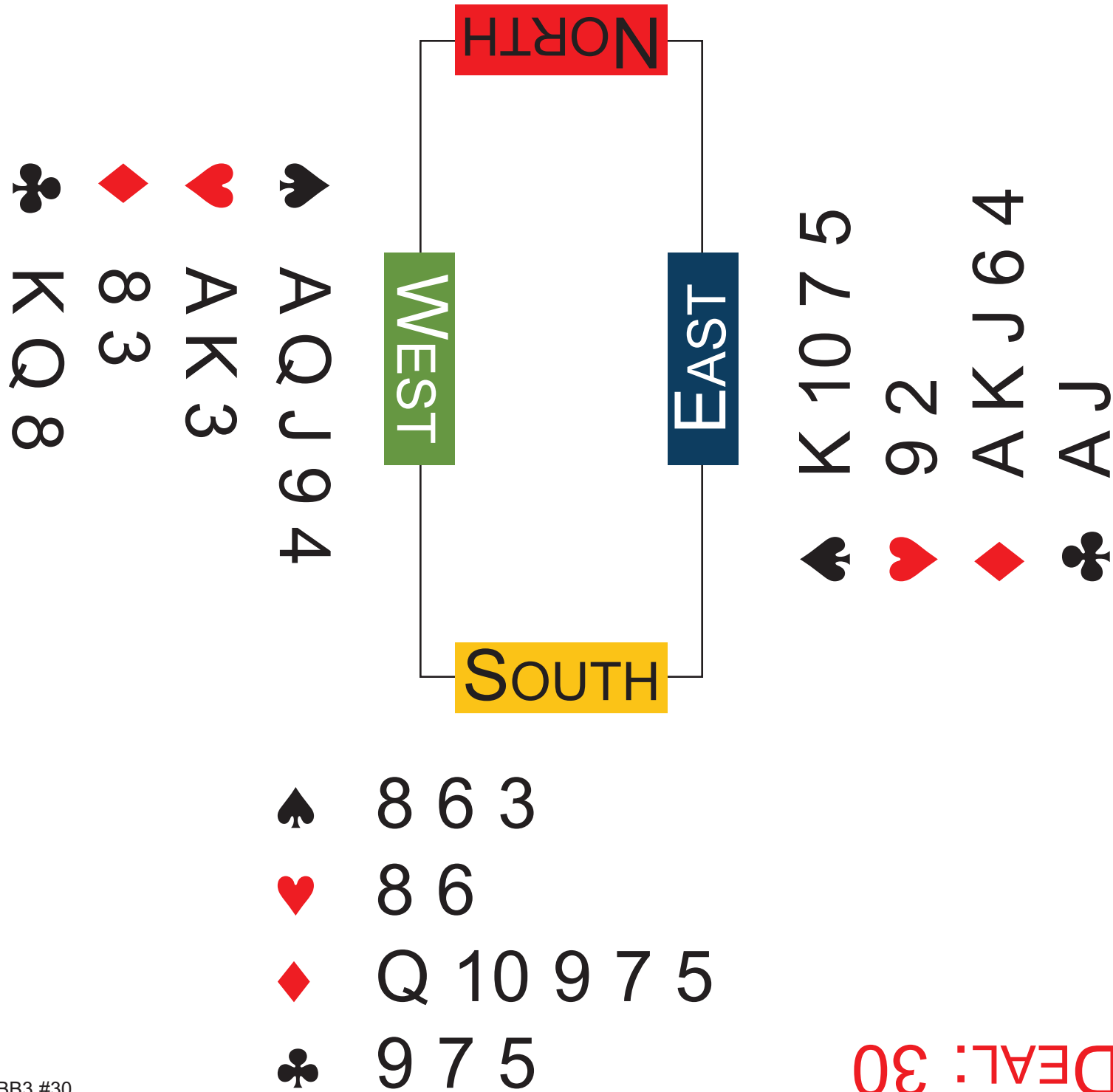

NORTH

DEAL: 30
DLR: EAST
VUL: N-S



EAST

WEST

SOUTH

DEAL: 31

♠ K Q 10
 ♥ A K J 8 6 5
 ♦ J
 ♣ A K 6



♠ A 8 5 2
 ♥ 10 4
 ♦ Q 6 4 2
 ♣ Q J 9

♠ 9 7 4
 ♥ Q 9 2
 ♦ A K 10 9
 ♣ 8 5 3

♠ J 6 3
 ♥ 7 3
 ♦ 8 7 5 3
 ♣ 10 7 4 2

DEAL: 31

NORTH

DEAL: 31
DLR: SOUTH
VUL: E-W

EAST

WEST



SOUTH

DEAL: 32

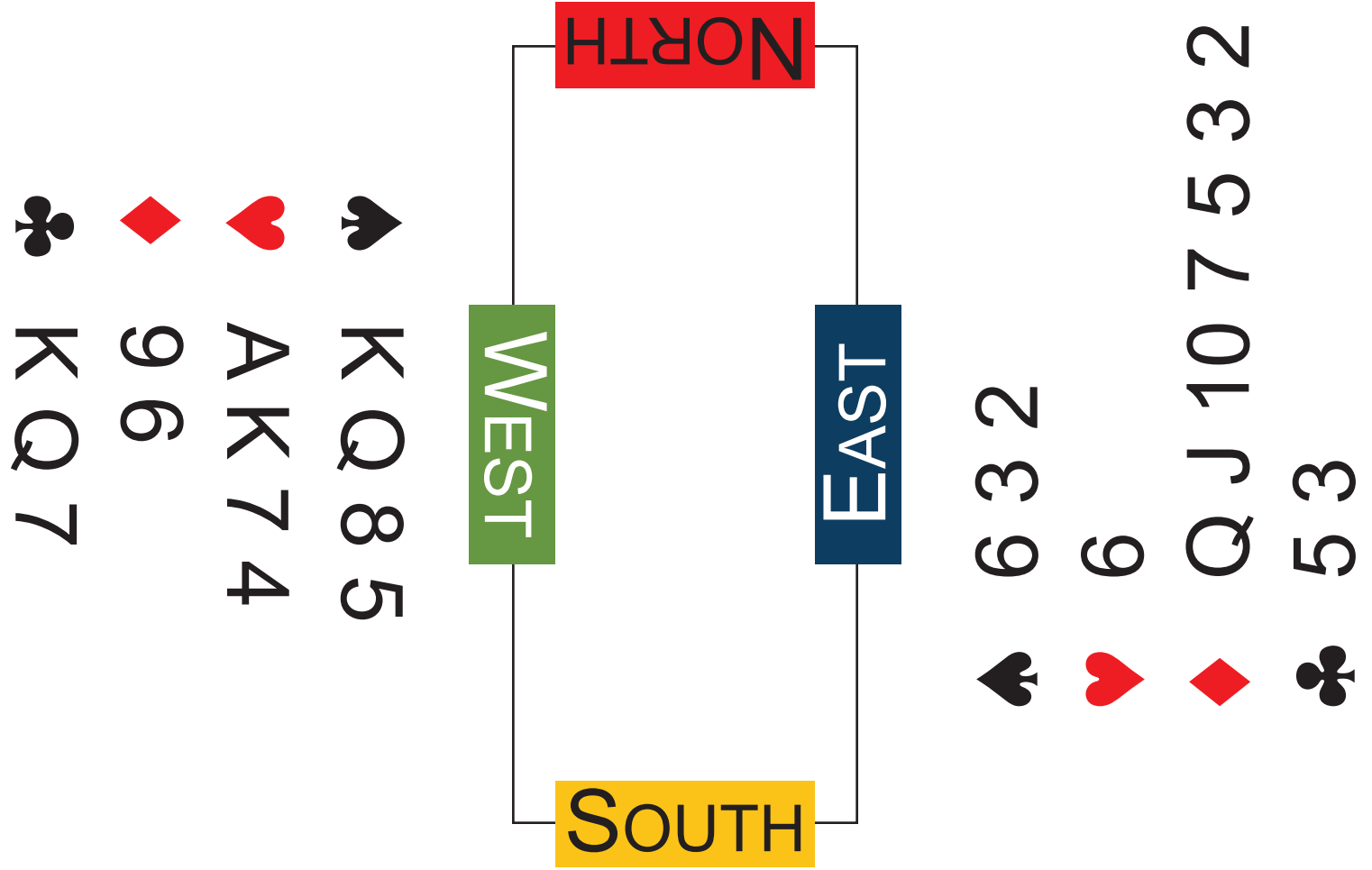

DEAL: 32

NORTH

DEAL: 32
DLR: WEST
VUL: BOTH



WEST

EAST

SOUTH